

# Specifications

MTL Model NO.	Safety Description			Polarities Available			Typical Applications	Basic Circuit		Max. end-To-end resistance $\Omega$	Vwkg at $1\mu A$ V	Vmax V	Fuse rating mA	Remarks
	V	$\Omega$	mA	+	-	ac		Hazardous	Safe					
7761ac	9	90	100			↙	Strain-gauge bridges		107	6.0	7.0	100		

## Dimensions in mm

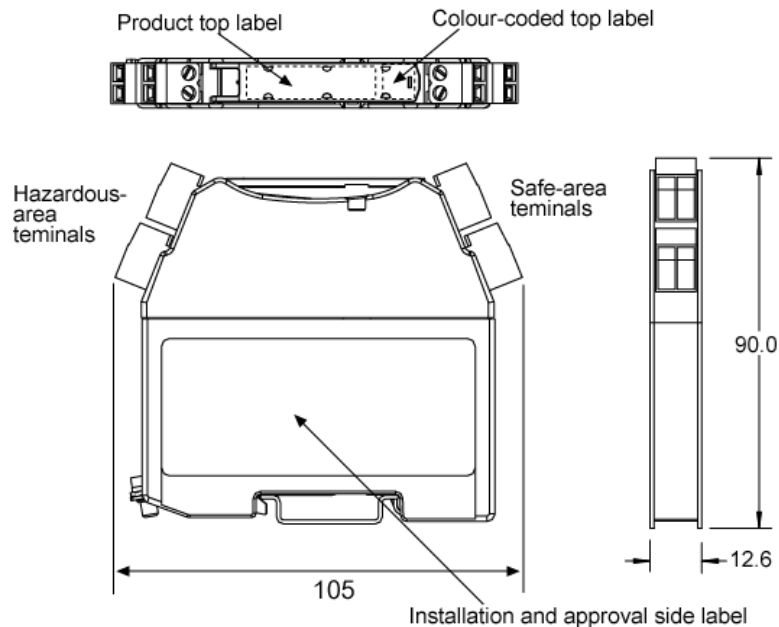

## Common Specification

### Ambient temperature and humidity limits

Ambient temperature and humidity limits

-20°C~+60°C continuous working

-40°C~+80°C storage

5~95% RH

### Working voltage

0.6V : Leakage current is  $10\mu A$

### Terminations

Removable terminals accommodate conductors up to 2.5mm<sup>2</sup> (13AWG), Hazardous-area terminals are identified by blue labels. Removal force >15N

### Colour coding of barrier label

Grey: Non-polarised

Red : positive polarity

Black : negative polarity

### Weight

140g approx

### Certificate No. (BASEEFA)

BAS01ATEX7217

REV.	PROJECT NAME:	<b>Cooper Industries Japan K.K.</b> Tokyo, Japan TEL: +81-(0)3-6430-3128 FAX: +81-(0)3-6430-3129	Title		MTL7761ac Specification		
REV.	USER NAME :		SIZE	FSCM NO	Drawing No.	rev	
REV.	JOB NAME :		DATE:	2009/9/29		SS-MTL7761ac(E)	
	Ref no.:	CHKD	K.T	DRAWN	I.S	SCALE N/A	SHEET 1 / 1